

# MIC-KEY\* CARE GUIDE

## INTRODUCTION TO TUBE FEEDING

Good nutrition maintains health, growth and healing. Many different medical problems are treated by gastrostomies when the person cannot eat or eat enough to meet nutritional requirements. A gastrostomy delivers nourishment and liquid through a tube into the stomach. Formula suitable for tube feeding may be commercially prepared or may be blenderized table food prescribed by the specialist.

Adequate nutrition depends on the right type and amount of formula. Your specialist has prescribed your feeding schedule, formula, and amount of water.

## ABOUT THE MIC-KEY\*

A MIC-KEY\* Low Profile feeding tube (MIC-KEY\*) has been inserted into your stomach through the abdominal wall. There is an inflatable balloon at one end and an external base at the other. This tube allows the intake of food and water that your body requires.

Your specialist has measured you to ensure that you have the right size MIC-KEY\* feeding tube. You also received care and maintenance instructions. This pamphlet will help you remember the instructions. You received instructions about your diet and medication. Follow the instructions closely and never put any other diet or medication through your tube.

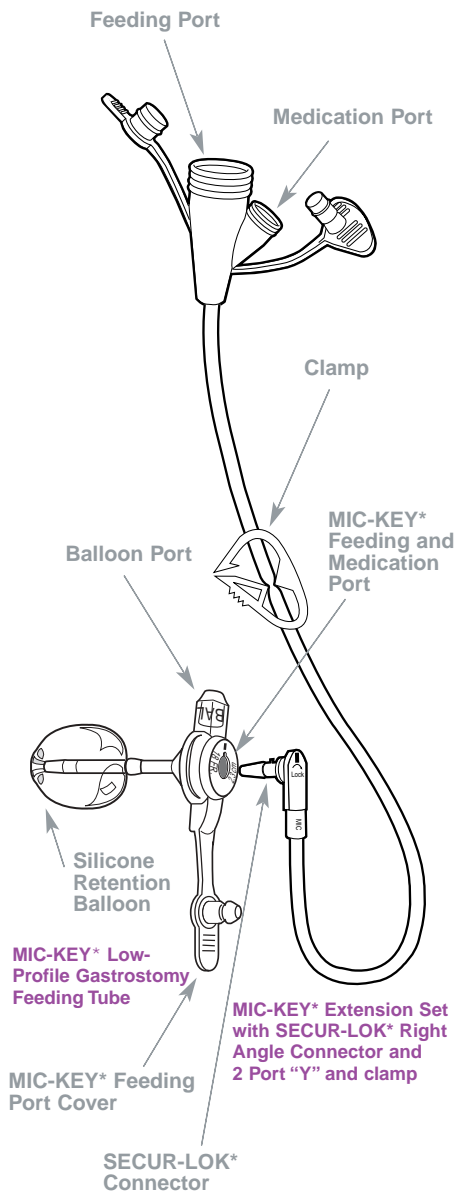

# MIC-KEY\* CARE GUIDE

## THE EXTERNAL BASE

The external base holds the tube in place yet allows air circulation to the skin around and underneath it. The bottom of the base should rest just above the skin surface. A good fit is considered one-eighth inch (3 mm) above the skin, or approximately the thickness of a dime.



## THE MIC-KEY\* FEEDING PORT

Nourishment and liquids are delivered through the gastrostomy tube and into the stomach through the feeding and medication port. When nourishment or liquids are not being administered, the feeding port is capped off with the attached feeding port cover.

An anti-reflux valve is located inside and toward the top of the feeding port. This helps prevent stomach contents from leaking out of the tube. The use of the extension set will open or unlock the valve. The extension set is used for feeding and venting (also called decompression or burping).

It is important to keep the feeding port and anti-reflux valve clean. Dried formula may lodge inside the recess and hold the valve open. The best preventative measure is to flush thoroughly with enough water to clear all formula and to use cotton tipped applicators and water. Be sure that residual formula is not left to pool and dry inside the valve opening.

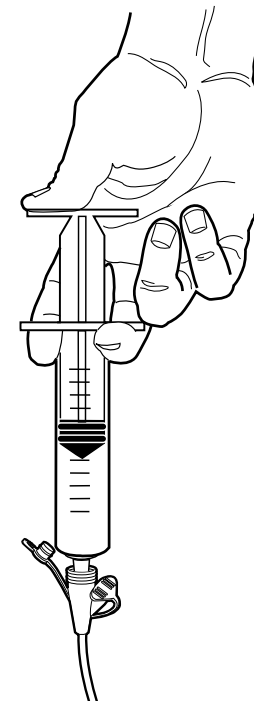

## THE SILICONE RETENTION BALLOON

Your feeding tube has a balloon inside the stomach that has been inflated to hold the tube in place. Your specialist filled it with water when the tube was inserted. Check the balloon volume once a week.

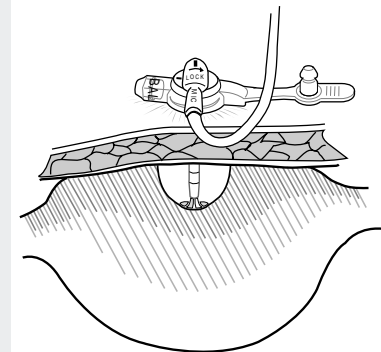

# MIC-KEY\* CARE GUIDE

## THE BALLOON VALVE

The balloon, which holds the tube in place, is inflated and deflated by inserting a luer slip syringe into the balloon valve. It should only be used when checking the balloon volume or replacing the MIC-KEY\*. It is important to never attempt to feed through the balloon valve. It is also important to keep this valve clean. The recess in the valve can trap foreign material and it must be clean to function properly.

## ACCESSORIES

### THE MIC-KEY\* EXTENSION SET

Your MIC-KEY\* kit contains an extension set. Use this extension set for continuous feeding with a formula pump. To attach the extension set, align the black line on the extension set with black line on the feeding port. Insert the "nose" of the Secur-Lok\* connector into the feeding port and rotate it one quarter turn clockwise. Open the extension set feeding port and attach the feeding bag connector to the extension set with a firm push and twist. The extension set "swivels" with movement and allows you to change position during feeding.

Wash the extension set after every feeding with warm soapy water and rinse it thoroughly. Prompt flushing and rinsing prevents the formula from drying and building up. Extension sets are disposable and should be replaced every few weeks.

### THE MIC-KEY\* BOLUS EXTENSION SET

Your MIC-KEY\* feeding tube kit also contains a MIC-KEY\* bolus extension set. Some people receive several feedings during the day. Use the bolus extension set to feed with a catheter tip syringe or feeding bag. It normally takes twenty to forty minutes to bolus feed. This method resembles a normal feeding pattern.

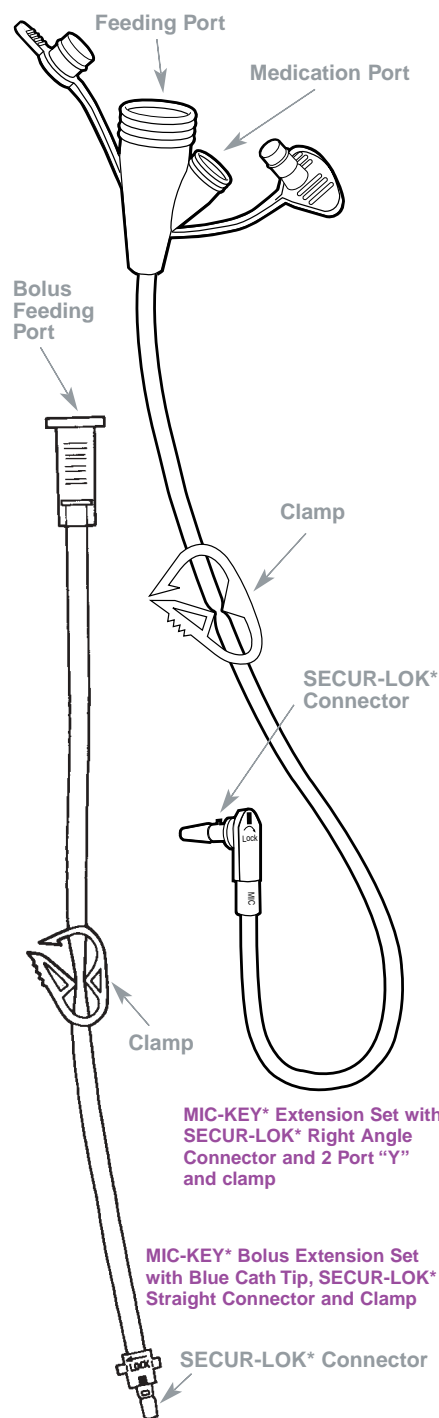

# MIC-KEY\* CARE GUIDE

## THE SYRINGES

A 6ml luer slip syringe is included with your feeding tube kit. Use it to inflate and deflate the retention balloon when periodically checking its volume and when you replace the MIC-KEY\* feeding tube.

Your MIC-KEY\* feeding tube kit also includes a 35 ml catheter tip syringe. It should be used when priming and flushing the extension sets, and when checking for proper placement of the MIC-KEY\* feeding tube.

## CARE AND USE

Clean the MIC-KEY\* feeding tube daily. Care is simple and easy. Just keep the tube and the skin around the tube (stoma) clean and dry.

The following supplies will make your work easier:

- soap and water
- cotton-tip applicators
- tissues
- luer slip syringe

The balloon holds your feeding tube in place. Check the volume of water in the balloon at least once a week. To do this, attach the luer slip syringe to the balloon port and withdraw all the water while leaving the feeding tube in place. If there is less fluid than the amount originally prescribed, replace it with the prescribed amount. Distilled or sterile water is a good choice for the replacement fluid once the stoma site has healed. (Never fill the balloon with air. Air will rapidly migrate out of the balloon and the MIC-KEY\* feeding tube will not stay in place).

Rotate the MIC-KEY\* feeding tube in a full circle when you perform daily tube care. This will prevent the tube or balloon from adhering to the skin.

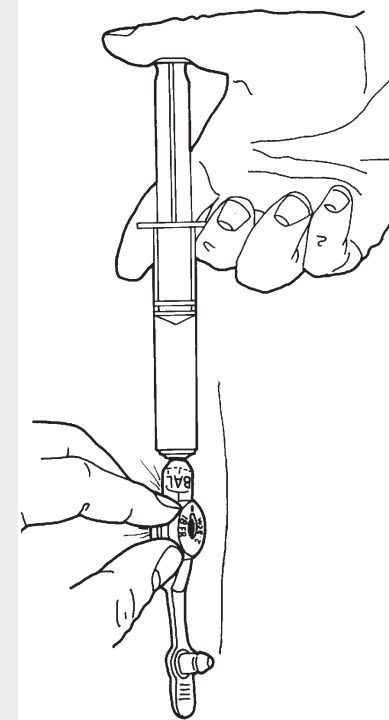
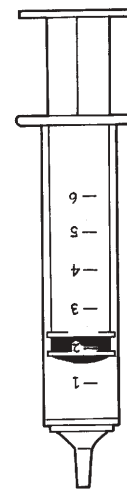

# MIC-KEY\* CARE GUIDE

## MAINTENANCE OF THE MIC-KEY\* LOW-PROFILE GASTROSTOMY FEEDING TUBE

ALWAYS WASH YOUR HANDS WITH WARM SOAPY WATER BEFORE TOUCHING YOUR TUBE.

Develop a habit of inspecting the skin around the tube (stoma) after feeding. Make sure the skin is clean and dry. Observe the stoma for a few minutes checking for gastric leakage. If you use a dressing, change it when it becomes wet or soiled. Never allow a wet dressing to remain in contact with the skin. Note: The MIC-KEY\* feeding tube does not require a dressing. Gently clean the skin around the stoma. Rotate the MIC-KEY\* feeding tube and clean again. Use cotton-tip applicators or a soft cloth, using soap and warm water. If you think soap is irritating the skin, try cleansing with water alone or try another soap.

Clean the feeding port with a cotton tip applicator or soft cloth to remove oil or food. If you receive a continuous feeding, flush the tube and the extension set tubing at least three times daily.

AVOID PUNCTURING OR TEARING ANY PART OF THE MIC-KEY\* LOW-PROFILE GASTROSTOMY FEEDING TUBE.

## FEEDING THROUGH THE MIC-KEY\*

### PROPER PLACEMENT

Before feeding, check the tube to be sure that it is not clogged or displaced outside the stomach. To do this, connect the extension set to the MIC-KEY\* feeding tube and attach a Monoject catheter tip syringe with 10 ml's of water to the extension set feeding port. Pull back on the plunger. When you see stomach contents in the tube, flush the MIC-KEY\* feeding tube with water. Stomach contents are normally yellow or clear unless there is food in the stomach. If you feel resistance as you inject the water, pull back stomach contents again, then try to re-inject the water. Check for leaking around the stoma.

Another method is to draw 5 to 10 ml's of air into a syringe. Place a stethoscope on the

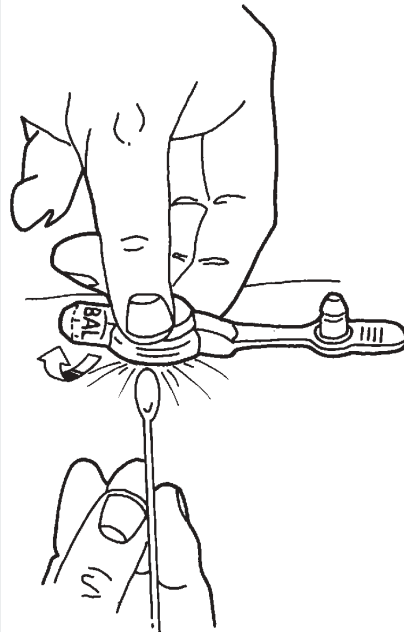

# MIC-KEY\* CARE GUIDE

left side of the abdomen just above the waist. Inject the air into the extension set feeding port and listen for the stomach to "growl". Try again if you do not hear it. If you still do not hear it, do not proceed to feed. Contact the specialist and report the problem.

### RESIDUAL

Another advantage of the MIC-KEY\* feeding tube is the ability to measure stomach residual without a decompression tube. Residual is the amount of gastric fluid and formula left in the stomach four hours after feeding. The stomach may not always empty completely. The amount of residual varies and may depend upon your activity or position. Check for residual if the formula backs up in the extension tubing or if you feel nauseated. Generally, replace the residual back into the stomach. It contains important electrolytes and nutrients. Check the residual again in 30 minutes and resume the feeding if the amount is less than you obtained at the first check.

### DECOMPRESSION OR VENTING

Your specialist may instruct you to decompress (release air or food from the stomach) before or after feedings. To decompress the stomach, attach the extension set or bolus extension set to the MIC-KEY\* feeding tube. Drain into a collecting cup or bag.

# MIC-KEY\* CARE GUIDE

## CONTINUOUS FEEDING

The specialist will recommend the type of formula best for you.

1. Clean the tops of formula cans and shake well. (If using powdered formula, it should be prepared fresh every day. Refer to the information section of this booklet for the prescribed amount. Label each formula batch with the date and time you prepared it.)
2. Wash hands with soap and water and dry thoroughly.
3. Fill the feeding administration bag with formula.
4. Connect the feeding administration bag tubing to the MIC-KEY\* extension set feeding port.
5. Purge air from the tubing by allowing formula to run through the tubing. When formula has reached the extension set SECUR-LOK\* Connector, clamp the tubing.
6. Remove the feeding port cover. Insert the extension set into the feeding port by matching the black lines on the extension set and feeding port. Lock the extension set into place by turning the connector CLOCKWISE until you feel a slight resistance (approximately three-quarters turn). DO NOT turn the connector past the stop point.
7. Connect the feeding administration bag tubing to the pump. Set the pump rate according to the manufacturer's instructions. Unclamp the tubing and begin feeding.
8. When the feeding is nearly finished, add the prescribed amount of water to the feeding bag.
9. After the formula and water have been administered, disconnect the feeding administration bag tubing from the extension set. Flush the extension set with 10–20 ml's of warm water or until the tubing is clear.
10. Disconnect the extension set from the MIC-KEY\* feeding tube by rotating it COUNTER-CLOCKWISE until the black line on the feeding port lines up with the black line on the extension set. Gently detach the extension set and cap the MIC-KEY\* feeding tube securely with the attached feeding port cover.
11. Wash the extension set and feeding bag in warm soapy water immediately after each use. Rinse thoroughly and air dry.

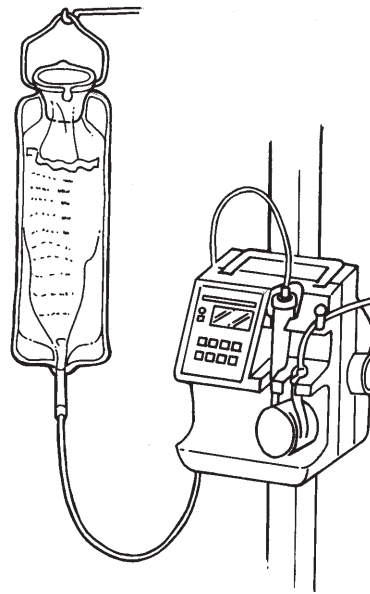
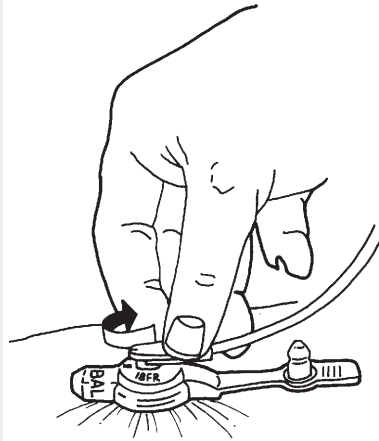

# MIC-KEY\* CARE GUIDE

## BOLUS FEEDING

1. Attach a water filled catheter tip syringe to the MIC-KEY\* bolus extension set. Prime the extension set by filling it with water.
2. Attach the bolus extension set to the feeding port by matching the black lines on the extension set and feeding port. Insert the bolus extension set locking adapter into the feeding port and rotate it CLOCKWISE until you feel a slight resistance (approximately three-quarters turn). DO NOT turn the connector past the stop point.
3. Clamp the extension set.
4. Disconnect the syringe and remove the syringe plunger. Reattach the syringe.
5. Slowly pour the formula into the syringe and unclamp the tubing. Keep the syringe filled to prevent air from entering the stomach. Adjust the flow rate by raising or lowering the syringe. The feeding should finish in 20 to 40 minutes.
6. When the syringe is nearly empty, add the prescribed amount of water to the syringe.
7. After the formula and water have been administered, clamp the tube and fill the syringe with 10–20 ml of warm water. Reinsert the syringe plunger and unclamp the tube. Flush the bolus extension set until the tubing is clear. Proceed to Step 12.
8. To bolus feed with a ("Gravity Drip") bag, fill the bag with the desired amount of formula and evacuate the air from the bag's tubing. Attach the bolus extension set to the feeding administration bag tubing, prime it and clamp the tubing. Attach the bolus extension set to the feeding port and open the clamp. Adjust the flow by opening or closing the clamp on the bag's tubing.
9. When the feeding is nearly finished, administer the prescribed amount of water by adding it to the feeding administration bag.
10. After the formula and water have been administered, disconnect the bolus extension set from the feeding administration bag tubing.
11. Flush the bolus extension set tubing with 10–20 ml's of warm water or until the tubing is clear.
12. Disconnect the bolus extension set and wash in warm soapy water until the tubing is clear.

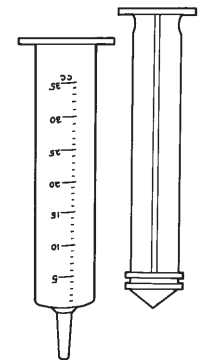
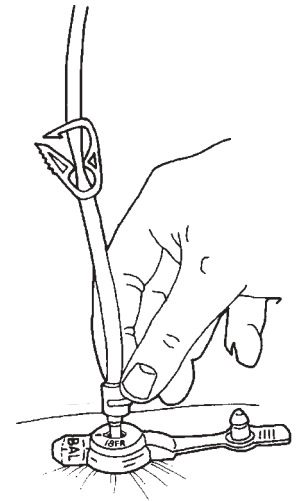

# MIC-KEY\* CARE GUIDE

## MEDICATIONS

Give medications in liquid form. Thick medication can plug the feeding port and is easier to give when diluted with water.

When a medication is only available in tablets or capsules, check with the pharmacist first to make sure it can be crushed and mixed with water.

Do not mix medication with formula unless directed by your specialist.

Small amounts of medication can be diluted with water in a luer slip syringe and injected directly into feeding port. This method eliminates the need for extension tubing. Flush with at least 10 ml's of water after giving the medication.

## REPLACING THE MIC-KEY\* FEEDING TUBE

The specialist will decide when to replace the MIC-KEY\* feeding tube. Look for the change date on the information page in this handbook. You may change the tube yourself if the specialist trains you to do so.

### To replace a MIC-KEY\* feeding tube:

1. Remove the new MIC-KEY\* feeding tube from the package. Fill the balloon with 5ml sterile or distilled water.
2. Remove the syringe and observe the balloon. It should be symmetrical. Check for leaks. Remove the water from the balloon.
3. Attach the luer slip syringe to the balloon valve of the MIC-KEY\* feeding tube that is in the patient's stomach. Pull back on the plunger until all of the water is out of the balloon.
4. Gently remove the MIC-KEY\* feeding tube from the patient's stomach. It may help to use a little water soluble lubricant as you are removing it.
5. Lubricate the tip of the replacement MIC-KEY\* feeding tube with a water soluble agent. **DO NOT USE OIL OR PETROLEUM JELLY.**
6. Gently guide the new tube into the stoma. Insert the tube all the way until the MIC-KEY\* feeding tube is flat against the skin.

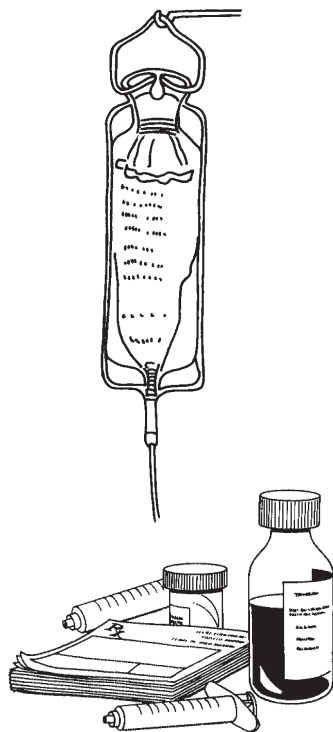

# MIC-KEY\* CARE GUIDE

7. Hold the tube in place and fill the balloon with 5 ml (3-5 ml for 12 French sizes) distilled or sterile water. Do not use air.

**NEVER FILL THE BALLOON WITH MORE THAN 10 ML (5 ML FOR 12 FRENCH SIZES) OF FLUID.**

8. Position the balloon against the stomach wall by pulling the MIC-KEY\* feeding tube up and away very gently until it stops.
9. Wipe away fluid or lubricant from the tube and stoma.
10. Check the tube for correct placement. Insert an extension set into the feeding port and...
  - (a) Listen for air
  - (b) Aspirate residual stomach contents

## CHILDREN'S CORNER

Children are special and they have special needs. If you are caring for a child with a gastrostomy, the following points may help.

### CHILDREN HAVE SMALL STOMACHS

Infants develop the capacity to hold large feedings in their stomachs as they grow. Feedings usually begin with frequent small amounts of formula. Bolus feedings take 20 to 40 minutes. A gravity flow system or a pump regulates a slow steady flow and leaves you free to do other things. Be patient, and slowly increase the amount of formula given during the feeding.

If the child's stomach is full, formula may leak around the stoma. The child may also act colicky and vomit, or burp up formula. Ask your specialist if decompression or venting is appropriate for this child.

### CHILDREN ARE GROWING

Children with gastrostomies have the same basic growth and developmental needs as other children.

### HOW MUCH WATER?

When our bodies need water we feel thirsty and we drink more. Gastrostomy patients are the same. If the weather is warm or the child has a fever, additional water may prevent dehydration. Ask your specialists for guidelines.

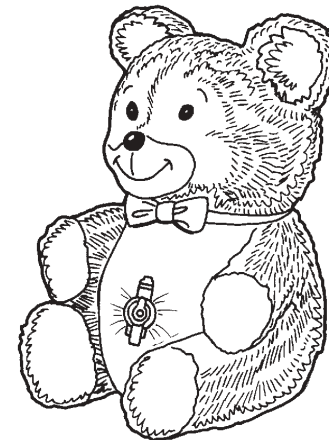
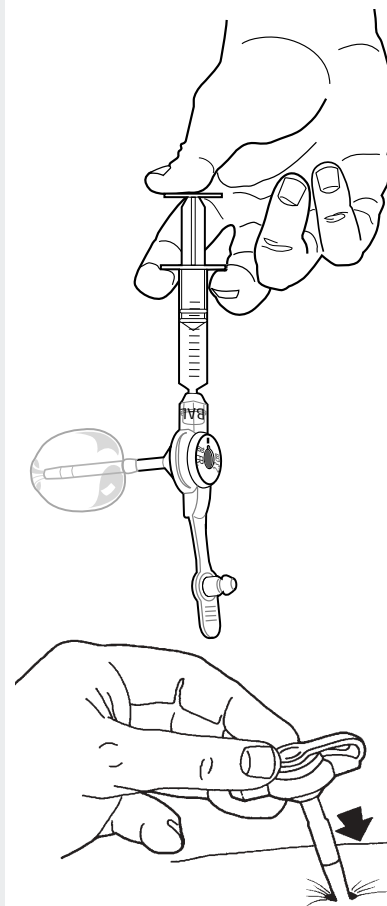



# MIC-KEY\* CARE GUIDE

## LEARNING ABOUT FOOD

Although your child receives nourishment through a tube, group participation at the table during meals is important. It gives the child an opportunity to experience food. Encourage your child to touch and taste, just like everyone else, even if it makes a mess around the high chair.

## MOUTH

The mouth is a very sensitive part of the baby's body. Even if the child cannot suck and swallow well enough to eat, the sucking reflex is there. Sucking seems to comfort babies. Experiment with a pacifier. Use it to stimulate your child's lips, gums, and tongue during feedings. As the baby grows, provide other opportunities to chew or suck.

Talk with your specialist about oral stimulation and ways to promote normal development.

## NORMAL ACTIVITY

It is important for babies to roll over on their stomachs. They learn to push up and crawl this way. The MIC-KEY\* feeding tube low profile design may make it easier for this activity to occur.



## PROBLEM SOLVING

### STOMACH CONTENTS LEAK OUT AROUND THE TUBE

First, check stomach residual. The stomach may be too full or contain gas. If the stomach contains too much residual more than a few times, the patient may be getting too much formula at one time. If you are using an intermittent (bolus) feeding, consider switching to continuous. If using a continuous feeding, try decreasing the flow rate. Assure that the balloon inside the stomach is filled by gently pulling on the tube and checking for resistance. Check the Gastrostomy Information Section for the prescribed balloon fill volume. Test the balloon by attaching a luer slip syringe to the inflation valve. Withdraw the fluid from the balloon and note the volume in the syringe. If the amount is less than prescribed, refill the balloon with the prescribed amount of water, wait 10 to 20 minutes and repeat the procedure. If the prescribed volume of water



# MIC-KEY\* CARE GUIDE

is still in the balloon, try increasing the volume by 2 ml at a time until the leak stops. The maximum fill volume is 10 ml's (5 ml for 12 French sizes). Do not exceed this.

**CAUTION: USE CARE WHILE FILLING OR REMOVING WATER FROM THE BALLOON. THE MIC-KEY\* FEEDING TUBE MAY EASILY BE PULLED OUT.**

### IF THE FEEDING TUBE BECOMES DISCONNECTED

Stop the pump. Estimate the amount of formula lost. Thoroughly wipe the tube connections with soap and water or alcohol. They must be free from oil or formula build up. Clean inside the extension set feeding port with a cotton-tipped applicator and alcohol. Irrigate the tube with warm water. Dry the connections and firmly reconnect the tubes with a quarter turn. Resume the feeding, replacing the estimated volume lost during the disconnection.

### BALLOON LEAKS OR RUPTURES

Always keep a replacement MIC-KEY\* feeding tube or conventional gastrostomy tube at home. Silicone balloons generally last several months, but the life span of the balloon varies according to several factors. These factors may include medication, volume of water used to fill the balloon, gastric pH, and tube care.

### TUBE BLOCKAGE

To prevent tube blockage, flush the tube with 10–20 ml warm water. If your specialist has instructed otherwise, follow your specialists instructions.

1. Before and after each feeding.
2. Before and after giving medications.
3. Every 3 to 4 hours if the patient is receiving continuous feedings.
4. After checking for stomach content residuals.

Do not mix medication with formula. Medication should be in liquid form when possible. If not, crush finely and make sure it is well dispersed in water. Give multiple medications one at a time and rinse the tube with warm water before and after. Flush the tube with 5 ml water between each medication.

### BALLOON WILL NOT DEFLATE

If you cannot extract water from the balloon

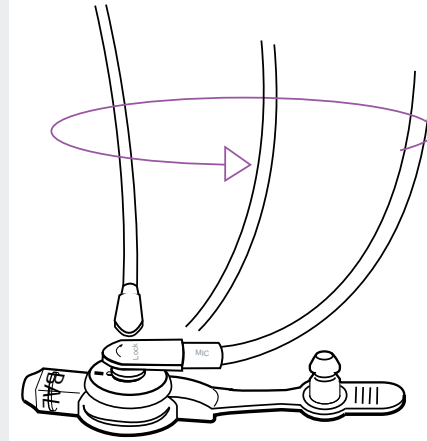

with the syringe, ensure the recess in the balloon valve is clean. Occasionally the recess will trap spills of formula or other material as a result of normal daily living. Be sure the valve is not frozen closed by food. Clean inside the recess, then firmly seat the syringe into the valve, push and twist one quarter turn. Try pulling back on the plunger again. If the balloon will not deflate, use the end of a large paper clip to depress the valve and release the water. **BE SURE YOU HAVE A REPLACEMENT TUBE TO INSERT INTO STOMA.**

### STOMA AND SKIN PROBLEMS

Bleeding stoma. Notify your specialist.

**IF THE STOMA BLEEDS, (MORE THAN A SMALL AMOUNT) OR IF IT LOOKS LIKE BLOOD IS MIXED WITH STOMACH CONTENTS, CALL YOUR SPECIALIST IMMEDIATELY.**

Redness or soreness around the skin and stoma may be the result of gastric leakage. Clean and dry the area frequently. Be sure to rotate the MIC-KEY\* feeding tube in a full circle during daily tube care.

### CALL THE SPECIALIST IF:

1. The stoma is persistently red and sore.
2. The red area is larger than 2.5 cm in diameter.
3. The stoma emits an odor.
4. The skin surrounding the stoma is swollen.
5. There is pus around the stoma.
6. The patient has a fever.

### GRANULATION TISSUE

Granulation tissue is the result of the body trying to repair the surgical incision. The tissue may proliferate and require treatment. If it bleeds or a large amount of tissue builds up, contact your specialist.

## SPECIAL CHILDREN'S PROBLEMS

### IF A CHILD VOMITS

When vomiting occurs, it is possible to inhale formula and stomach contents into the lungs. Aspiration is the medical term for this and it can lead to serious medical problems.



If a child develops difficulty breathing during or immediately after a feeding, **STOP THE FEEDING AT ONCE, DRAIN (DECOMPRESS) THE STOMACH AND CALL THE SPECIALIST.**

If the child feels nauseated, wait one to two hours before feeding and then resume the feeding slowly. The same is true for vomiting. Wait and feed at a slower rate.

**IF NAUSEA OR VOMITING PERSIST, CALL THE SPECIALIST.**

**NOTE:** Some children have gastroesophageal reflux. Food routinely flows backward up the esophagus. Correct feeding position is **VERY IMPORTANT** for these children. Place them in an upright position or at least a 30-degree angle before feeding. Notify your specialist if your child vomits after feeding.

### SMALLER TUBES

The tubes used in children may have a smaller diameter than those used in adults. Smaller tubes clog more easily but require less water to flush out. Infants usually receive a 10 to 15 ml flush.

### DIARRHEA

Two reasons for diarrhea are rapid formula administration or spoiled formula. Try giving the formula at a slower rate and refrigerate leftover formula.

**MIX NEW FORMULA FOR EACH FEEDING AND NEVER KEEP MIXED FORMULA LONGER THAN 24 HOURS.**

Changes in formula, medications or feeding routines can also cause diarrhea.

**IF DIARRHEA PERSISTS FOR MORE THAN THREE DAYS, CALL YOUR SPECIALIST.**

### CONSTIPATION

Certain types of formulas cause constipation in sensitive individuals. Inactivity, change in formula, medication, or change in the feeding routine can also cause constipation.

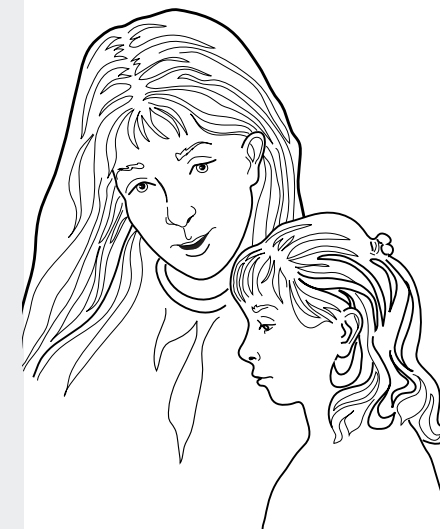

---

## GLOSSARY OF TERMS

---

- ASPIRATION:** Accidentally inhaling liquid into the windpipe and/or lungs.
- BOLUS FEEDING:** Large amounts of formula delivered through the tube.
- CONSTIPATION:** Bowel movements (stools) sometimes painful, and difficult to pass.
- CONTINUOUS FEEDING:** Small amounts of formula constantly throughout the day (or night) without interruption.
- DIARRHEA:** Frequent, loose, watery bowel movements.
- ESOPHAGUS:** The passage in the throat through which food passes from the mouth into the stomach.
- FEEDING PUMP:** A small machine, plug-in or battery powered, that automatically controls the amount of formula being delivered through the feeding tube.
- FEEDING SET:** Tubing that connects the feeding container to the feeding tube.
- FEEDING TUBE:** Tube through which formula flows into the stomach or intestine. Gastrostomy or jejunostomy tube.
- G-TUBE:** Gastrostomy tube. A tube that passes through the skin into the stomach. Also called feeding tube.
- GASTROESOPHAGEAL REFLUX:** Backing up of formula or gastric juice from the stomach into the esophagus.
- GASTROINTESTINAL DECOMPRESSION:** The removal of gas or fluid from the stomach. (also called “venting”).
- GASTROSTOMY:** A surgical opening (stoma) through the skin into the stomach.
- GRANULATION TISSUE:** Fleishy projections formed on the surface of the stoma that will later form fibrous scar tissue.
- GRAVITY DRIP:** Formula flows into the stomach by gravity.
- INTERMITTENT FEEDING:** Feeding smaller amounts of formula frequently during the day or night. Intermittent feeding supplements night-time continuous feeding.
- NUTRIENTS:** Food or any substance that nourishes the body - protein, carbohydrate, fat, vitamins, minerals, and water.
- STOMA:** Surgical opening through which a feeding tube can enter the body.
- STOMACH RESIDUAL:** Contents of the last feeding remaining in the stomach just before the next feeding is to be given.
- SYMMETRICAL:** Correspondence in shape, size, and relative position of parts on opposite sides.



## CONTENTS

I	INTRODUCTION TO TUBE FEEDING	1
II	ABOUT THE MIC-KEY*	1
	- The External Base	2
	- The MIC-KEY* Feeding Port	2
	- The Silicone Retention Balloon	2
	- The Balloon Valve	3
III	ACCESSORIES	3
	- The MIC-KEY* Extension Set	3
	- The Bolus Extension Set	3
	- The Syringes	4
IV	CARE AND USE	4
	- Maintenance of the MIC-KEY* Feeding Tube	5
V	FEEDING THROUGH THE MIC-KEY*	5
	- Proper Placement	5
	- Residual	6
	- Decompression or Venting	6
	- Continuous Feeding	7
	- Bolus Feeding	8
	- Medications	9
VI	REPLACING THE MIC-KEY*	9
VII	CHILDREN'S CORNER	10
VIII	PROBLEM SOLVING	11
IX	SPECIAL CHILDREN'S PROBLEMS	14
X	GLOSSARY OF TERMS	16

## GASTROSTOMY INFORMATION

NAME \_\_\_\_\_ PHONE \_\_\_\_\_

SPECIALIST \_\_\_\_\_ PHONE \_\_\_\_\_

PLACEMENT DATE \_\_\_\_\_ TYPE \_\_\_\_\_

TUBE REPLACEMENT DATES \_\_\_\_\_

### TUBE SPECIFICATIONS:

FRENCH SIZE \_\_\_\_\_ LENGTH IN CENTIMETERS \_\_\_\_\_

BALLOON VOLUME \_\_\_\_\_ LOT NUMBER \_\_\_\_\_

### FORMULA PREPARATION:

TYPE OF FORMULA \_\_\_\_\_ AMOUNT OF FORMULA \_\_\_\_\_

FEEDING TIMES \_\_\_\_\_

AMOUNT OF EACH FEEDING \_\_\_\_\_ AMOUNT OF WATER \_\_\_\_\_

PUMP SETTING OR FLOW RATE \_\_\_\_\_ ADDITIONAL INGREDIENTS \_\_\_\_\_

BLENDERIZED TABLE FOOD: **FOLLOW THE DOCTOR'S INSTRUCTIONS**

FLUSH WITH \_\_\_\_\_ ml WATER BEFORE AND AFTER EVERY FEEDING

MIX WELL AND REFRIGERATE. **FOLLOW SPECIALIST'S INSTRUCTIONS**

IF YOU HAVE ANY QUESTIONS ABOUT YOUR MIC GASTROSTOMY TUBE,  
YOU MAY CALL KIMBERLY-CLARK\* HEALTH CARE TOLL FREE AT  
1-800-528-5591

For more information  
about MIC-KEY\* products,  
visit our websites:

Clinicians :

[www.kchealthcare.com/mic-key.com](http://www.kchealthcare.com/mic-key.com)

- **Links to relevant journal articles**
- **Directions for use**
- **Care guide pamphlets**
- **Animated care instructions**

Patients:

[www.mic-key.com](http://www.mic-key.com)

- **Patient success stories**
- **Links to relevant journal articles**
- **“Be the Expert” forum articles**
- **Directions for use**
- **Care guide pamphlets**
- **Animated care instructions**

Manufactured by Ballard Medical Products, Draper, Utah 84020 USA  
Distributed in the U.S. by Kimberly-Clark Global Sales, Inc. Roswell, GA. 30076 USA  
Kimberly-Clark N.V., Belgicastraat 13, 1930 Zaventem, Belgium  
<http://www.kchealthcare.com> In USA call 1-800-528-5591;  
International call + 1 801 572 6800

CE 0344

R8201B 10/05

\*Registered Trademark or Trademark of Kimberly-Clark Worldwide, Inc. or its affiliates.  
©2005 KCWW. All rights reserved.

**Kimberly-Clark\***

**MIC-KEY\***

**LOW-PROFILE GASTROSTOMY  
FEEDING TUBE**

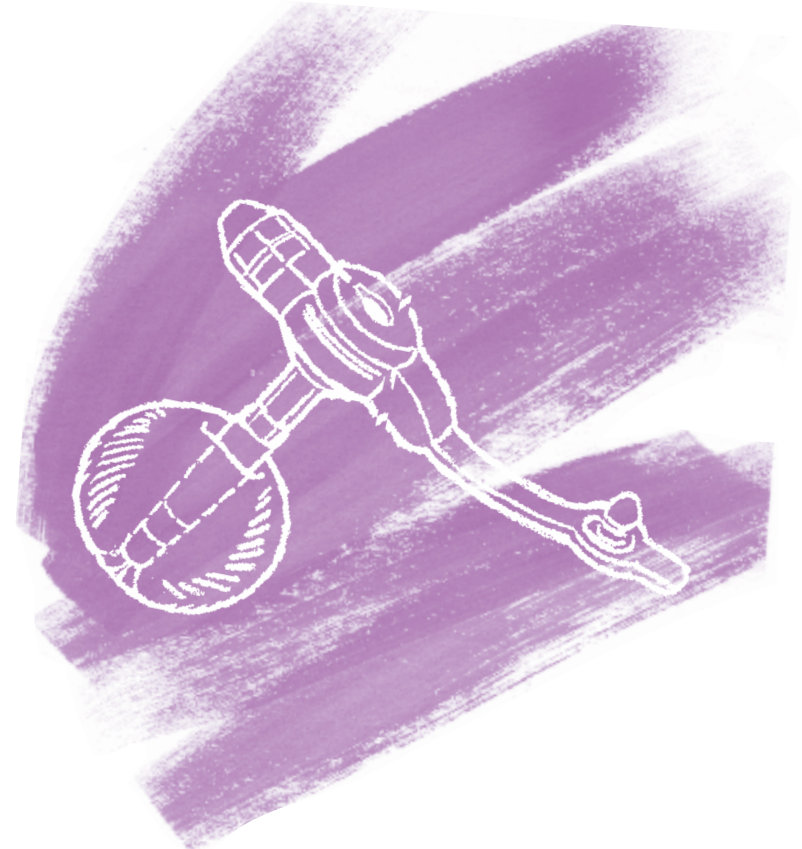

**YOUR GUIDE TO PROPER CARE**

Visit our websites:

Clinicians - [www.kchealthcare.com/mic-key.com](http://www.kchealthcare.com/mic-key.com)

Patients - [www.mic-key.com](http://www.mic-key.com)