



# TABLE OF CONTENTS

---

INTRODUCTION .....	3
IN THIS MANUAL.....	3
INTENDED USE .....	3
WARNINGS AND CAUTIONS.....	3
WARNINGS .....	3
CAUTIONS.....	4
SYMBOL KEY .....	5
SYSTEM OVERVIEW.....	6
GLOSSARY .....	7
HOW TO CONTACT RESPIRONICS.....	7
SETUP.....	9
CONNECTING THE THERAPY DEVICE .....	9
DAILY USE .....	10
DEVICE CONTROLS.....	13
HUMIDIFIER CONTROL KNOB .....	13
BLUE LED DISPLAY .....	13
CLEANING AND SERVICE .....	15
CLEANING.....	15
WATER TANK.....	15
HEATER PLATE AND HUMIDIFIER BASE .....	16
HUMIDIFIER OUTLET.....	16
SERVICE .....	16
TRAVELING WITH THE SYSTEM .....	16
PACKING THE SYSTEM.....	16
DC POWER.....	17
INTERNATIONAL TRAVEL .....	17
TROUBLESHOOTING .....	19
SPECIFICATIONS .....	25
SIZE.....	25
WATER CAPACITY .....	25
PRODUCT USE, TRANSPORT, AND STORAGE .....	25
STANDARDS COMPLIANCE.....	25
ELECTRICAL .....	25

HEATER SETTINGS.....	26
PRESSURE DROP WITH HUMIDIFIER .....	26
HUMIDITY RANGE.....	26
LED TYPE.....	26
WEEE/ROHS RECYCLING DIRECTIVES.....	26
EMC INFORMATION .....	27
LIMITED WARRANTY .....	31

# INTRODUCTION

---

## IN THIS MANUAL

---

This manual covers the following topics:

- Introduction  
Intended Use, Warnings and Cautions, Symbols, System Overview, Glossary
- Setup  
Connecting the Therapy Device, Daily Use
- Device Controls  
Humidifier Knob, Blue LED Display
- Cleaning and Service  
Water Tank, Humidifier Plate and Platform, Humidifier Outlet, Service
- Traveling with the System  
Packing the System, DC Power, International Travel
- Troubleshooting
- Specifications

## INTENDED USE

---

The M Series Heated Humidifier is an accessory for M Series positive pressure ventilation systems to provide moisture to the patient circuit. It is intended for use in spontaneously breathing patients weighing over 30 kg, in the home or hospital/institutional environment, who use mask-applied positive pressure ventilation therapy.

## WARNINGS AND CAUTIONS

---

### WARNINGS

*A warning indicates the possibility for injury to the user or the operator.*

- Use the humidifier only for its intended use as described in this manual. Use only accessories recommended by Respironics.
- Never operate the humidifier if any of the parts are damaged, if it is not working properly, or if the humidifier has been dropped or mishandled. Do not use the humidifier if the water tank is leaking or damaged in any way. Have any damaged parts replaced before continuing use.
- Allow the device to cool down before touching or removing the water tank.

- This equipment is not suitable for use in the presence of a flammable anesthetic mixture with air or with oxygen or nitrous oxide.
- Periodically inspect the humidifier power supply connector, power supply cord connector, and the AC power cord for signs of wear or damage. Replace the power supply and AC power cord if worn or damaged. If the humidifier power supply connector is worn or damaged, contact Respironics or your home care provider.
- When installing the water tank, do not allow any water to spill into the humidifier or therapy device.
- Pins of connectors identified with the ESD warning symbol () should not be touched. Connection should not be made to these connectors unless ESD precautionary procedures are used. Precautionary procedures include methods to prevent build-up of electrostatic discharge (e.g., air conditioning, humidification, conductive floor coverings, non-synthetic clothing), discharging one's body to the frame of the equipment or system or to earth or a large metal object, and bonding oneself by means of a wrist strap to the equipment or system or to earth.

## CAUTIONS











*A caution indicates the possibility of damage to the device.*

- If fluids are spilled onto the humidifier base, unplug the power cord from the AC wall outlet and allow the humidifier platform to drain and dry before using.
- Take precautions to protect furniture from water damage.
- Do not fill above line.
- Remove tank, empty all water, and replace empty tank before transporting the humidifier base.

**NOTE:** *Additional warnings, cautions, and notes are located throughout this manual.*

## SYMBOL KEY

The following symbols appear on the humidifier:

SYMBOL	DESCRIPTION
	Maximum Fill Line
	Hot Surface
	Electrostatic Discharge
	Attention, consult accompanying documents
	Compliant with the Waste Electrical and Electronic Equipment and Restriction of the Use of Certain Hazardous Substances in Electrical and Electronic Equipment (WEEE/RoHS) Recycling Directives
	Type BF Applied Part
	Class II (Double Insulated)
<b>IPX1</b>	Drip Proof Equipment
	European CE Marking
	Canadian/US Certification
	Notified Body Approval for Standards Compliance

## SYSTEM OVERVIEW

Figure 1 illustrates many of the device features and contents, described in the table below.

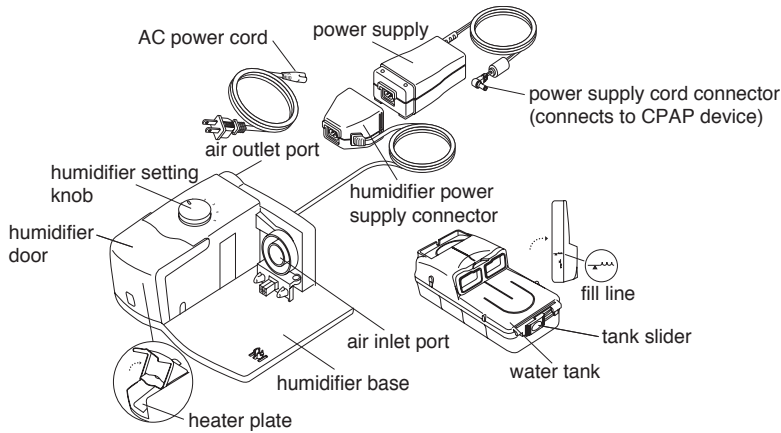

FIGURE 1: SYSTEM FEATURES AND CONTENTS

ITEM	DESCRIPTION
Humidifier Power Supply Connector	Plug the power supply into this adapter.
Power Supply	Use the power supply included with your therapy device.
Power Supply Cord Connector	Plug this cord into the DC inlet on the therapy device.
AC Power Cord	Use the cord included with your therapy device.
Humidifier Base	Connect your therapy device here.
Air Inlet Port	Connect to the outlet port on the therapy device.
Air Outlet Port	Connect the patient circuit here.
Heater Plate	Warms the water in the water tank.
Humidifier Door	Lift the door to access the water tank.
Water Tank	The removable water tank holds the water for humidification.
Fill Line	This indicates the maximum water level for safe operation.
Tank Slider	Use this to lock and unlock the humidifier tank halves.
Humidifier Setting Knob	Use this to reach the desired setting.

**NOTE:** Read all instructions before using the humidifier.

**NOTE:** This humidifier is specified for use with Respiration therapy devices only.

## GLOSSARY

---

The following terms and acronyms appear throughout this manual:

TERM/ACRONYM	DEFINITION
Active State	The operating mode in which humidity therapy is being provided.
BPM	Breaths per Minute
CPAP	Continuous Positive Airway Pressure
LED	Light Emitting Diode
LPM	Liters per Minute
Off State	The humidifier state that occurs when power is removed.
OSA	Obstructive Sleep Apnea
Safe State	The state in which the therapy device does not provide therapy. The device enters this state if an error is detected.
Standby State	The state of the humidifier when power is applied but humidification is turned off.

## HOW TO CONTACT RESPIRONICS

---

If you need to contact Respiroics directly, call the Respiroics Customer Service department at 1-724-387-4000 or +49 8152 93060. You can also use one of the following addresses:



Visit Respiroics web site at: [www.respiroics.com](http://www.respiroics.com)





# SETUP

---

**IMPORTANT!** Read and understand your therapy device's manual prior to using this humidifier with your therapy device.

## CONNECTING THE THERAPY DEVICE

---

1. When using a humidifier, the patient circuit attaches to the air outlet port on the humidifier. If your therapy device has the air outlet port connection attached, you must remove it from your therapy device before connecting to the humidifier.

To remove the port:

- a. Put your thumb underneath the port and insert your index finger into the port opening.
- b. Pivoting from the bottom, unsnap the port and pull it away from the device.

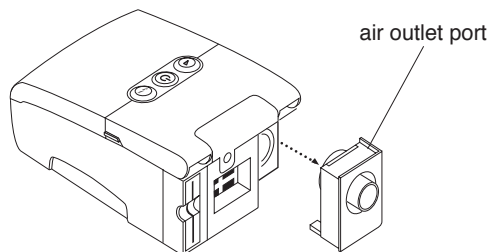

FIGURE 2: REMOVING THE THERAPY DEVICE AIR OUTLET PORT CONNECTOR

2. Place the therapy device on the humidifier base. Position the therapy device so that the air inlet port on the humidifier connects to the air outlet port on the device. Use the latch on the humidifier base as a guide to properly connect the therapy device to the humidifier.

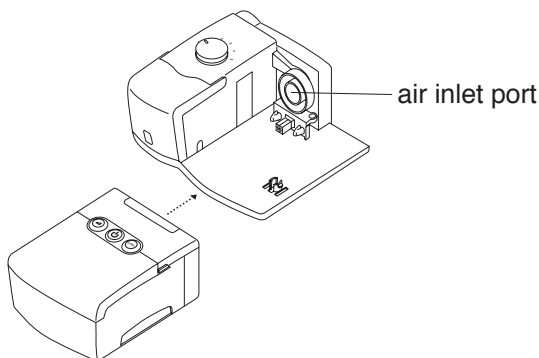

FIGURE 3: CONNECTING THE THERAPY DEVICE

## DAILY USE

---

1. Place the humidifier platform on a firm, flat surface lower than your sleeping position.

**NOTE:** Take appropriate precautions to protect furniture from water damage.

**CAUTION:** Do not turn the humidifier on without the water tank installed.

**WARNING!** Allow the humidifier heater plate and water to cool down for approximately 15 minutes before removing the water tank. A burn may result from touching the heater plate, coming in contact with the heated water, or touching the tank pan.

2. Lift the humidifier door and remove the water tank by sliding it out of the humidifier base.

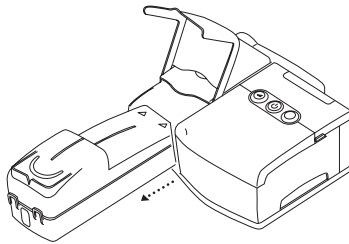

FIGURE 4: REMOVING THE WATER TANK

3. Rinse the tank with water. Fill the tank to the fill line with room temperature distilled water (approximately 1-2/3 cups or 325 ml).

**CAUTION:** Use only distilled water in the tank.

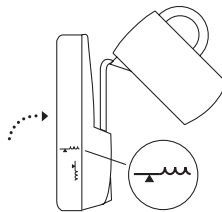

FIGURE 5: FILLING THE WATER TANK

**CAUTION:** Fill the humidifier with room temperature water only. Filling the humidifier with water that is too cold or too hot may cause errors in the humidifier, causing the blue LED to blink.

**CAUTION:** Do not overfill the water tank. Damage to the humidifier or therapy device may occur.

**CAUTION:** When installing the tank, do not allow any water to spill into the therapy device.

**CAUTION:** Do not move the humidifier when the water tank has water in it.

4. Place the water tank back in the humidifier.

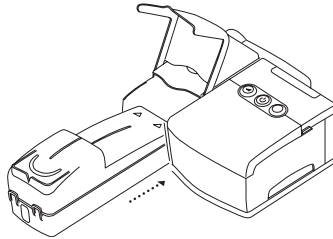

**FIGURE 6: INSTALLING THE WATER TANK**

5. Connect the humidifier power supply connector to the device power supply. Plug the AC power cord into the humidifier power supply connector, then plug the power cord into an electrical outlet.

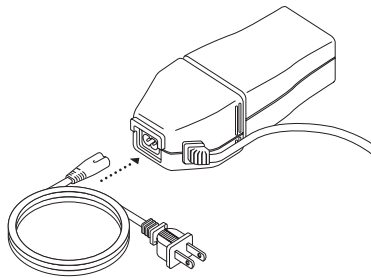

**FIGURE 7: CONNECTING THE AC POWER CORD**

6. Plug the power supply cord connector into the therapy device.

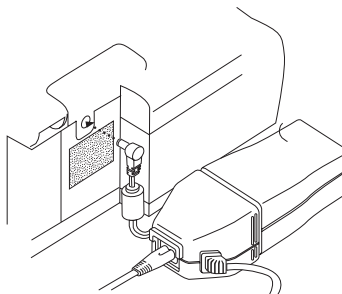

**FIGURE 8: CONNECTING THE POWER SUPPLY**

- Attach the swivel, with the flexible tubing attached, to the humidifier's air outlet port. Or, attach the tubing directly to the air outlet port. See Figure 9.

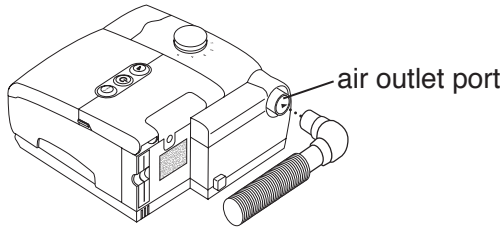

FIGURE 9: CONNECTING THE PATIENT CIRCUIT

**IMPORTANT!** Before each use, examine the flexible tubing for any kinks, damage, or debris. If necessary, clean the tubing to remove the debris. Replace any damaged tubing.

- Press the  button to turn on the blower.

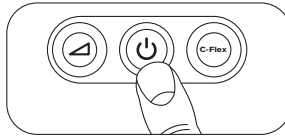

FIGURE 10: TURNING ON THE BLOWER

**NOTE:** For information on your M Series therapy device settings, refer to the manual included with your device.

- Turn on the humidifier by turning the humidifier knob to the desired setting. The blue LED on the humidifier knob will turn on and therapy can begin.

**CAUTION:** The humidifier knob must remain on 0 if there is no water in the water tank or if the water tank is not installed.

**IMPORTANT!** The blue LED will NOT turn on if you did not start the blower on the therapy device or if the humidifier knob is set to 0.

**IMPORTANT!** The ideal humidity setting depends on room temperature and humidity. Initially a setting of 2 is recommended. You can adjust this setting at any time. Turn the humidifier knob to change the setting.

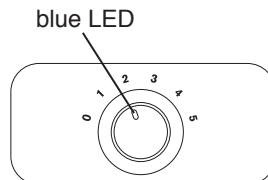

FIGURE 11: SELECTING A HUMIDIFIER SETTING

# DEVICE CONTROLS

---

## HUMIDIFIER CONTROL KNOB

---

The humidifier control knob is used to control the output of the humidifier. The knob has 6 settings, ranging from 0 to 5, with 0 indicating OFF.

## BLUE LED DISPLAY

---

The blue LED, located on the humidifier control knob, reflects the status of the humidifier. It provides four indication levels as described below:

STATE	LED DISPLAY
Power Up	On for a half second
Off State	Continuous Off
Active State	Continuous On
Error State	On/Off flashing that indicates an error condition exists. This is either a safe state condition or an AC loss error (heater plate not heating)



# CLEANING AND SERVICE

---

## CLEANING

---

**WARNING!** To avoid electrical shock, always unplug the power cord from the wall outlet or DC power source before cleaning the humidifier.

## WATER TANK

**WARNING!** Empty and clean the water tank daily to prevent mold and bacteria growth.

**WARNING!** Allow the water in the tank to cool to room temperature before removing the tank from the humidifier.

1. Turn the therapy device off, turn the humidifier knob to 0, and allow approximately 15 minutes for the heater plate and water to cool.
2. Open the humidifier door, and then slide the water tank out of the humidifier base. Empty any remaining water.
3. Push the tank slider to the right, and then gently pull apart the top and bottom halves of the humidifier tank by pulling upward on the tank tabs or tank inlet/outlet.

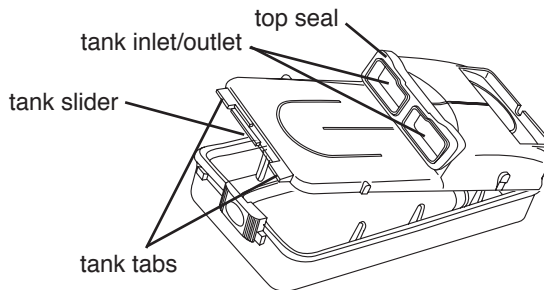

FIGURE 12: SEPARATING THE WATER TANK FOR CLEANING

4. Wash all parts using one of the following methods:
  - a. Place on the top rack of the dishwasher. Rinse the parts with clean water and allow them to air dry.
  - b. Wash in a solution of warm water and a mild dishwashing detergent. Rinse the parts with clean water and allow them to air dry.



5. Prior to use, reassemble and fill the water tank. Inspect the water tank for any leaks or damage. Replace the water tank if any damage is present.

**NOTE:** *If the top seal is loosened or falls off during cleaning, see the Troubleshooting section later in this manual for reattachment and/or replacement information.*

## HEATER PLATE AND HUMIDIFIER BASE

1. Clean the humidifier base by wiping it with a damp cloth. Allow the platform to air dry before reconnecting the power cord and therapy device.
2. Inspect the humidifier base for any damage and replace it if necessary.

## HUMIDIFIER OUTLET

Clean the humidifier outlet from the back of the device, using a damp bottle brush or a damp cloth. To clean, insert the brush or cloth approximately 3 inches into the outlet opening.

## SERVICE

---

The humidifier does not require routine servicing. See the *Troubleshooting* section later in the manual for additional information.

## TRAVELING WITH THE SYSTEM

---

### PACKING THE SYSTEM

When you are traveling, the optional M Series carrying case can be used for carry-on luggage only. The carrying case will not protect the humidifier if it is put through checked baggage.

**CAUTION:** *Always empty the water tank before packing the humidifier.*

For your convenience at airport security stations, there is a note on the bottom of the humidifier stating that it is medical equipment. It may be helpful to bring this manual along with you to help security personnel understand the device.

## DC POWER

This humidifier is suitable for use with typical DC-to-AC inverters and UPSs (uninterruptible power supplies). (200 watts at 120 V and 400 watts at 220 V)

The Respironics DC Power Cord can be used to operate the therapy device and humidifier in a stationary recreational vehicle, boat, or motor home. The Respironics DC Battery Adapter Cable, when used with the DC Power Cord, enables the device to be operated from a 12 VDC free-standing battery.

**NOTE:** *When the DC Power Cord is used, the humidifier will not heat up unless it is also plugged into an inverter. The blue LED will flash when the heater plate does not heat up. In this mode, the humidifier acts as a passover, or non-heated, humidifier.*

**CAUTION:** *When DC power is obtained from a vehicle battery, the device should not be used while the vehicle's engine is running. Damage to the vehicle or the device and humidifier may occur.*

**CAUTION:** *Only use a Respironics DC Power Cord and Battery Adapter Cable. Use of any other system may cause damage to the device or vehicle.*

Refer to the instructions supplied with the DC power cord and adapter cable for information on how to operate the therapy device and humidifier using DC power.

## INTERNATIONAL TRAVEL

If you are traveling to a country with a line voltage different than the one you are currently using, a different power cord or an international plug adapter may be required to make your power cord compatible with the power outlets of the country to which you are traveling. Contact your home care provider for additional information.



# TROUBLESHOOTING

The table below lists some of the problems you may experience with your humidifier and possible solutions to those problems.

PROBLEM	WHY IT HAPPENED	WHAT TO DO
Nothing happens when you apply power to the humidifier.	Loss of AC/DC power or the device is unplugged.	<p>Following the <i>Daily Use</i> section earlier in this manual, check the outlet power and verify that the humidifier and therapy device are properly plugged in. Make sure the AC power cord is connected correctly to the power supply and the power supply cord is correctly plugged into the wall. Check if the blue LED is blinking. If it is blinking, follow the steps under <i>The Blue LED is Blinking</i> problem on page 20 of this manual.</p> <p>If the problem continues to occur, contact your home care provider. Return the humidifier, therapy device, and power supply to your provider, so they can determine if the problem is with the therapy device, humidifier, or power supply.</p>
The humidifier door has become detached from the device.	The door may come off if the humidifier is dropped or mishandled.	<p>The device will continue to function properly without the door attached.</p> <p>To reattach the door, make sure it is properly oriented with the humidifier, and then snap the door back into place.</p> <p>If the humidifier does not operate properly after being dropped or mishandled, contact your home care provider or Respironics.</p>
The humidifier is cracked or damaged.	The humidifier was dropped or mishandled.	<p>If the humidifier does not operate properly after being dropped or mishandled, contact your home care provider or Respironics.</p>

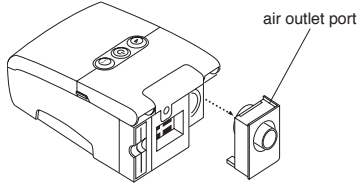
PROBLEM	WHY IT HAPPENED	WHAT TO DO
<p>The blue LED is blinking.</p>	<ol style="list-style-type: none"> <li>1. There is no communication between the therapy device and the humidifier.</li> <li>2. The therapy device is not seated properly on the humidifier platform.</li> <li>3. The heater plate is not heating.</li> </ol>	<ol style="list-style-type: none"> <li>1. Following the <i>Daily Use</i> section earlier in this manual, check the outlet power and verify that the humidifier and therapy device are properly plugged in. Make sure the AC power cord is connected correctly to the power supply and the power supply cord is correctly plugged into the wall. If the problem continues to occur, contact your home care provider. Return the humidifier, therapy device, and power supply to your provider, so they can determine if the problem is with the therapy device, humidifier, or power supply.</li> <li>2. Remove the therapy device from the humidifier base and reconnect. Be sure to use the guide on the humidifier base to slide the therapy device onto the base. Make sure the air inlet port on the humidifier connects securely to the air outlet port on the device.</li> </ol> <p>Make sure you removed the therapy device air outlet port. <i>It MUST be removed before connecting to the humidifier.</i></p> <p>To remove the port:</p> <ol style="list-style-type: none"> <li>a. Put your thumb underneath the port and insert your index finger into the port opening.</li> <li>b. Pivoting from the bottom, unsnap the port and pull it away from the device.</li> </ol>  <p>3. Check the power connections to the humidifier. If the problem continues, contact your home care provider or Respironics.</p> <p><i>NOTE: If the humidifier is functioning but the water is not heating, you can temporarily use the humidifier as a passover humidifier.</i></p>

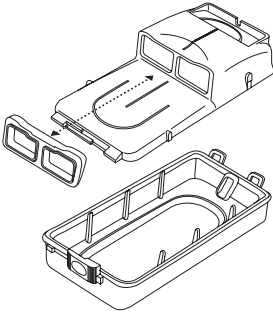
PROBLEM	WHY IT HAPPENED	WHAT TO DO
<p>Water tank top seal has fallen off.</p>	<p>The seal may become loose or fall off during cleaning.</p>	<p>Check the seal for any tears or damage. If it is damaged, contact your home care provider. If not, reconnect as shown below.</p> 

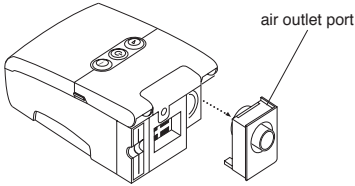
PROBLEM	WHY IT HAPPENED	WHAT TO DO
<p>High Leak</p>	<ol style="list-style-type: none"> <li>1. The tubing is not connected correctly and doesn't seal properly.</li> <li>2. The therapy device is not seated correctly on the humidifier base.</li> <li>3. The humidifier tank is not properly seated in the humidifier.</li> <li>4. The top seal is damaged or falls off.</li> </ol>	<ol style="list-style-type: none"> <li>1. Remove your mask and tubing and check for kinks or tears. If it is torn or damaged, contact your home care provider or Respironics for replacement tubing and/or mask.</li> </ol> <p>If the tubing is not damaged, reattach your tubing, turn on the airflow, and check to make sure you do not still feel air coming out of the port area.</p> <ol style="list-style-type: none"> <li>2. Remove the therapy device from the humidifier base and reconnect. Be sure to use the latch on the humidifier base as a guide to slide the therapy device onto the base. Make sure the air inlet port on the humidifier connects securely to the air outlet port on the device.</li> </ol> <p>Make sure you removed the therapy device air outlet port. <i>It MUST be removed before connecting to the humidifier.</i></p> <p>To remove the port:</p> <ol style="list-style-type: none"> <li>a. Put your thumb underneath the port and insert your index finger into the port opening.</li> <li>b. Pivoting from the bottom, unsnap the port and pull it away from the device.</li> </ol>  <ol style="list-style-type: none"> <li>3. Remove the water tank from the humidifier base, and then slide the tank back in the humidifier, making sure it is pushed back as far as it can go.</li> <li>4. Check the seal for any tears or damage. If it is damaged, contact your home care provider. If not, reconnect as shown on page 21.</li> </ol>

PROBLEM	WHY IT HAPPENED	WHAT TO DO
<p>The humidifier has fallen off your table or nightstand.</p>	<p>The humidifier may not have been properly seated on the nightstand, or the placement of the tubing may have caused the device to fall.</p>	<p>Always make sure your humidifier is placed on a hard, flat surface so the rubber feet on the bottom of the humidifier base can adhere to the surface (make sure there is no fabric under the base). The humidifier must be level for proper operation.</p> <p>Also, place the humidifier away from the edge of the nightstand or table, so it doesn't accidentally get knocked off the table.</p> <p>If the humidifier falls and water gets into the therapy device, drain all water out of the therapy device. Allow it to air dry to make sure it is completely dry before reapplying power.</p> <p>If the placement of the tubing causes the humidifier to fall, make sure that you use proper hose management when setting up your device. Route the tubing behind the bed's headboard.</p> <p>If the humidifier does not operate correctly after falling, contact your home care provider or Respironics.</p>

*NOTE: For information on troubleshooting your therapy device, see the manual included with your therapy device.*





# SPECIFICATIONS

---

## SIZE

Dimensions: 8.25" x 8.75" x 4"

Weight: < 2.2 lbs.

## WATER CAPACITY

1 2/3 cups at recommended water level

## PRODUCT USE, TRANSPORT, AND STORAGE

	Operation	Transport & Storage
Temperature:	41 to 95° F	-4 to 140° F
Humidity:	10 to 95% Non-condensing	15 to 95% Non-condensing
Atmospheric Pressure:	76.7 to 101 kPascals	N/A

## STANDARDS COMPLIANCE

This humidifier is designed to conform to the following standards:

IEC 60601-1 General Requirements for Safety of Medical Equipment

EN ISO 8185:1998 General Requirements for Humidification Systems

## ELECTRICAL

AC Power Consumption: 100 - 240 VAC, 50/60 Hz, 1.7 A max.

Type of Protection against Electric Shock: Class II Equipment

Degree of Protection against Electric Shock: Type BF Applied Part

Equipment Type: IPX1: Drip Proof Equipment

EMC Operation: Continuous

Electromagnetic Compatibility: This device meets the requirements of IEC 60601-1-2, 2nd edition.

## HEATER SETTINGS

1 to 5 (104° to 158° F)

## PRESSURE DROP WITH HUMIDIFIER

(max.) 0.3 cm H<sub>2</sub>O at 60 LPM flow

## HUMIDITY RANGE

10 to 40 mg H<sub>2</sub>O/l

## LED TYPE

Type 1 per IEC 60825-1

## WEEE/ROHS RECYCLING DIRECTIVES

If you are subject to the WEEE/RoHS recycling directives, refer to [www.respironics.com](http://www.respironics.com) for the passport for recycling this product.

# EMC INFORMATION

---

## GUIDANCE AND MANUFACTURER'S DECLARATION – ELECTROMAGNETIC EMISSIONS

---

This device is intended for use in the electromagnetic environment specified below. The user of this device should make sure it is used in such an environment.

EMISSIONS TEST	COMPLIANCE	ELECTROMAGNETIC ENVIRONMENT – GUIDANCE
RF emissions CISPR 11	Group 1	The device uses RF energy only for its internal function. Therefore, its RF emissions are very low and are not likely to cause any interference in nearby electronic equipment.
RF emissions CISPR 11	Class B	The device is suitable for use in all establishments, including domestic establishments and those directly connected to the public low-voltage power supply network.
Harmonic emissions IEC 61000-3-2	Class A	
Voltage fluctuations/Flicker emissions IEC 61000-3-3	Complies	

## GUIDANCE AND MANUFACTURER'S DECLARATION – ELECTROMAGNETIC IMMUNITY

This device is intended for use in the electromagnetic environment specified below. The user of this device should make sure it is used in such an environment.

IMMUNITY TEST	IEC 60601 TEST LEVEL	COMPLIANCE LEVEL	ELECTROMAGNETIC ENVIRONMENT – GUIDANCE
Electrostatic Discharge (ESD) IEC 61000-4-2	±6 kV contact ±8 kV air	±6 kV contact ±8 kV air	Floors should be wood, concrete or ceramic tile. If floors are covered with synthetic material, the relative humidity should be at least 30%.
Electrical fast Transient/burst IEC 61000-4-4	+2 kV for power supply lines +1 kV for input-output lines	±2 kV for supply mains ±1 kV for input/output lines	Mains power quality should be that of a typical home or hospital environment.
Surge IEC 61000-4-5	±1 kV differential mode ±2 kV common mode	±1 kV differential mode ±2 kV for common mode	Mains power quality should be that of a typical home or hospital environment.
Voltage dips, short interruptions and voltage variations on power supply input lines IEC 61000-4-11	<5% $U_T$ (>95% dip in $U_T$ ) for 0.5 cycle 40% $U_T$ (60% dip in $U_T$ ) for 5 cycles 70% $U_T$ (30% dip in $U_T$ ) for 25 cycles <5% $U_T$ (>95% dip in $U_T$ ) for 5 sec	<5% $U_T$ (>95% dip in $U_T$ ) for 0.5 cycle 40% $U_T$ (60% dip in $U_T$ ) for 5 cycles 70% $U_T$ (30% dip in $U_T$ ) for 25 cycles <5% $U_T$ (>95% dip in $U_T$ ) for 5 sec	Mains power quality should be that of a typical home or hospital environment.
NOTE: $U_T$ is the a.c. mains voltage prior to application of the test level.			

# GUIDANCE AND MANUFACTURER'S DECLARATION – ELECTROMAGNETIC IMMUNITY

This device is intended for use in the electromagnetic environment specified below. The user of this device should make sure it is used in such an environment.

IMMUNITY TEST	IEC 60601 TEST LEVEL	COMPLIANCE LEVEL	ELECTROMAGNETIC ENVIRONMENT – GUIDANCE
Power frequency (50/60 Hz) magnetic field  IEC 61000-4-8	3 a/m	3 a/m	Power frequency magnetic fields should be at levels characteristic of a typical location in a typical hospital or home environment.
Conducted RF IEC 61000-4-6  Radiated RF IEC 61000-4-3	3 Vrms 150 kHz to 80 MHz  3 V/m 80 MHz to 2.5 GHz	3 Vrms  3 V/m	<p>Portable and mobile RF communications equipment should be used no closer to any part of the device, including cables, than the recommended separation distance calculated from the equation applicable to the frequency of the transmitter.</p> <p>Recommended separation distance  <math>d = 1.2 \sqrt{P}</math></p> <p> <math>d = 1.2 \sqrt{P}</math>    80 MHz to 800 MHz  <math>d = 2.3 \sqrt{P}</math>    800 MHz to 2.5 GHz</p> <p>where P is the maximum output power rating of the transmitter in watts (W) according to the transmitter manufacturer and d is the recommended separation distance in meters (m).</p> <p>Field strengths from fixed RF transmitters, as determined by an electromagnetic site survey<sup>a</sup>, should be less than the compliance level in each frequency range.<sup>b</sup></p> <p>Interference may occur in the vicinity of equipment marked with the following symbol: </p>
<p>NOTE 1: At 80 MHz and 800 MHz, the higher frequency range applies.</p> <p>NOTE 2: These guidelines may not apply in all situations. Electromagnetic propagation is affected by absorption and reflection from structures, objects, and people.</p> <p>a Field strengths from fixed transmitters, such as base stations for radio (cellular/cordless) telephones and land mobile radios, amateur radio, AM and FM radio broadcast and TV broadcast cannot be predicted theoretically with accuracy. To assess the electromagnetic environment due to fixed RF transmitters, an electromagnetic site survey should be considered. If the measured field strength in the location in which the device is used exceeds the applicable RF compliance level above, the device should be observed to verify normal operation. If abnormal performance is observed, additional measures may be necessary, such as re-orienting or relocating the device.</p> <p>b Over the frequency range 150 kHz to 80 MHz, the field strengths should be less than 3 V/m.</p>			

## RECOMMENDED SEPARATION DISTANCES BETWEEN PORTABLE AND MOBILE RF COMMUNICATIONS EQUIPMENT AND THIS DEVICE

The device is intended for use in an electromagnetic environment in which radiated RF disturbances are controlled. The customer or the user of this device can help prevent electromagnetic interference by maintaining a minimum distance between portable and mobile RF communications equipment (transmitters) and this device as recommended below, according to the maximum output power of the communications equipment.

RATED MAXIMUM POWER OUTPUT OF TRANSMITTER W	SEPARATION DISTANCE ACCORDING TO FREQUENCY OF TRANSMITTER M		
	150 kHz TO 80 MHz $d = 1.2\sqrt{P}$	80 MHz TO 800 MHz $d = 1.2\sqrt{P}$	800 MHz TO 2.5 GHz $d = 2.3\sqrt{P}$
0.01	0.12	0.12	0.23
0.1	0.38	0.38	0.73
1	1.2	1.2	2.3
10	3.8	3.8	7.3
100	12	12	23

For transmitters rated at a maximum output power not listed above, the recommended separation distance  $d$  in meters (m) can be estimated using the equation applicable to the frequency of the transmitter, where  $P$  is the maximum output power rating of the transmitter in watts (W) according to the transmitter manufacturer.

NOTE 1: At 80 MHz and 800 MHz, the separation distance for the higher frequency range applies.

NOTE 2: These guidelines may not apply in all situations. Electromagnetic propagation is affected by absorption and reflection from structures, objects, and people.

## LIMITED WARRANTY

---

Respironics, Inc.<sup>®</sup> warrants that this humidifier shall be free from defects of workmanship and materials and will perform in accordance with the product specifications for a period of two (2) years from the date of sale by Respironics, Inc. to the dealer. If the product fails to perform in accordance with the product specifications, Respironics, Inc. will repair or replace, at its option, the defective material or part. Respironics, Inc. will pay customary freight charges from Respironics, Inc. to the dealer location only. This warranty does not cover damage caused by accident, misuse, abuse, alteration and other defects not related to material or workmanship. To exercise your rights under this warranty, contact your local, authorized Respironics, Inc. dealer or Respironics.



